

## Features

- Transceiver unit with independent
  - 1310nm MQW FP Laser diode transmitter
  - InGaAs PIN photodiode receiver
- Duplex SC receptacle and plastic package
- +5V Signal power supply, PECL interface logic level
- Qualified to meet the intent of Bellcore reliability practices
- Operates data rates from 5Mb/s to 200Mb/s(NRE)

## Application

- SONET/SDH
- ATM
- Ethernet

## General

The optical transceiver is a high performance, cost effective module for serial optical data communication application. It is designed to provide a SONET/SDH compliant link for OC-3/STM-1 short reach links.

## Transmitter Section

Transmitter is designed for single mode fiber and operates at a nominal wavelength of 1310nm. The transmitter module uses a MQW FP laser diode and full IEC825 and CDRH class 1 eye safety. It contains APC function, temperature compensation circuit and PECL logic interface, as shown in figure 1.

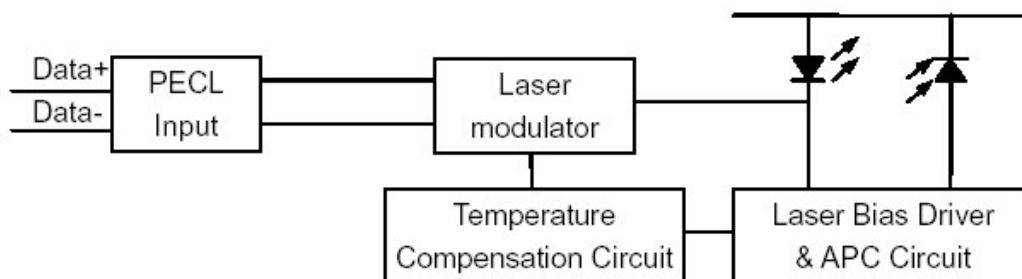
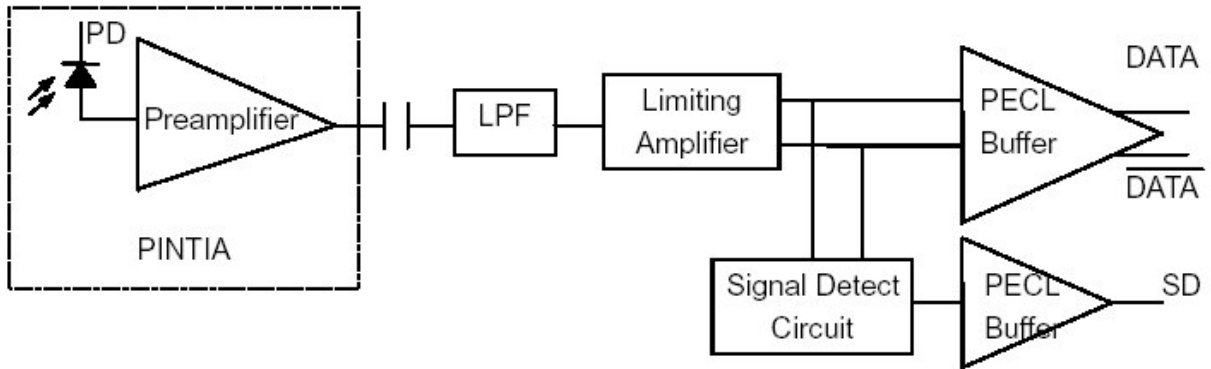

Figure 1. Transmitter Block Diagram

## Receiver Section

The receiver section uses a hermetic packaged front and receiver (InGaAs PIN and preamplifier). The postamplifier is ac coupled to preamplifier through a capacitor and a low pass filter, as shown in figure 2. The capacitor and LPF are enough to pass the signal from 5Mb/s to 200Mb/s without significant distortion or performance penalty. The LPF limits the preamplifier bandwidth to improve receiver sensitivity. Figure 2 shows the receiver section, which provides PECL logic differential outputs and a signal detect output.

As the input optical is decreased, Signal Detect will switch from high to low (deassert point). As the input optical power is increased from very low levels, Signal Detect will switch back from low to high (assert point). The assert level will be at least 0.5dB higher than the de-assert level.



**Figure 2. Receiver Block Diagram**

**Performance Specifications**

**Table1. Absolute Maximum Ratings**

Parameter	Symbol	Min	Max	Unit
Storage Temperature	Tst	-40	+85	°C
Input Voltage	-	GND	Vcc	V
Power Supply Voltage	Vcc-Vee	0	+6	V
Lead Soldering Temperature/Time	-	-	240/10	°C/S
Operating Temperature		-40	+85	°C

**Note:** Stress in excess of maximum absolute ratings can cause permanent damage to the module

**Tabel2. Operating Environment**

Parameter	Symbol	Min	Max	Unit
Power Supply Voltage	Vcc	+4.75	+5.25	V
Ambient Operating Temperature	-	-40	+85	°C

**Table 3. Optical and Electrical Characteristics**

Parameter	Symbol	Min	Typ	Max	Unit	Note
<b>Transmitter</b>						
Center Wavelength	$\lambda_p$	1261	1310	1360	nm	
Spectral Width	$\Delta\lambda$ (RMS)	-	-	7.7	nm	
Average Optical Output Power	Po	-25	-	-	dBm	
Extinction Ratio	EXT	8.2	-	-	dB	
Power Supply Current	Icc	-	70	180	mA	
Output Eye	Compliant with Bellcore TR-NWT-000253 ITU recommendation G.957					
Data InputS	PECL					
<b>Receiver</b>						
Parameter	Symbol	Min	Typ	Max	Unit	Note
Sensitivity	Pr	-	-36	-34	dBm	2
Maximum input power	Ps	-6	-	-	dBm	2
Signal Detect Assert Level	Pa(SD L-H)	-50	-	-	dBm	Low-level: Alarm
Signal Detect Deassert Level	Pd(SD H-L)	-	-	-36	dBm	
Signal Detect Hysteresis		-	3	-	dB	
Operating Current	Icc	-	80	100	mA	1
Data Outputs	PECL					
Alarm Output	PECL					

**PECL Input Pins SD, TD+ and TD-**

Parameter	Symbol	Min	Typ	Max	Unit	Note
Input HIGH voltage	V <sub>IH</sub>	VCC - 1165	-	VCC - 880	mV	3
Input LOW voltage	V <sub>IL</sub>	VCC - 1810	-	VCC - 1475	mV	3

**PECL Output Pins SD, RD+ and RD-**

Parameter	Symbol	Min	Typ	Max	Unit	Note
LOW-level output voltage	V <sub>OL</sub>	VCC - 1840	-	VCC - 1600	mV	3
HIGH-level output voltage	V <sub>OH</sub>	VCC - 1100	-	VCC - 900	mV	3

**Note :**

1. The current excludes the output load current.
2. Minimum Sensitivity and saturation levels for a  $2^{23} - 1$  PRBS with 72 ones and 72 zeros inserted (ITU recommendation G958)
3. RL=50R connected to a level of Vcc -2V.

**Pin Definitions**

**Pin Out Diagram**

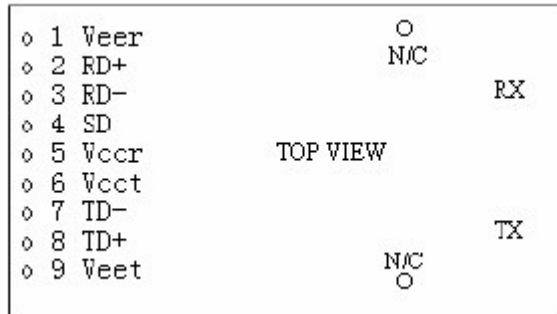

**Pin Description**

Pin#	Pin Name		Logic Level	Description
N/C	Mounting Studs			The two pins are not connected to the transceiver internal circuit.
1	VEER	RX Ground	N/C	Directly connect this pin to receiver signal ground plane.
2	RD+	RX Output Data	PECL	
3	RD-	RX Output Invert Data	PECL	
4	SD	RX Signal Detect	PECL	Normal Operation: Logic "1" Out put , represents that optical is present at receiver input. Fault Condition: Logic "0" output
5	VCCR	RX Power Supply	N/C	Provide +5V DC through the recommended power supply filter circuit. Place the filter circuit as close as possible to the VCCR pin.
6	VCCT	TX Power Supply	N/C	Provide +5V DC through the recommended power supply filter circuit. Place the filter circuit as close as possible to the VCCT pin
7	TD-	TX Invert Data Input	PECL	
8	TD+	TX Data Input	PECL	
9	VEET	TX Ground	N/C	Directly connect this pin to transmitter signal ground plane.

Package Information

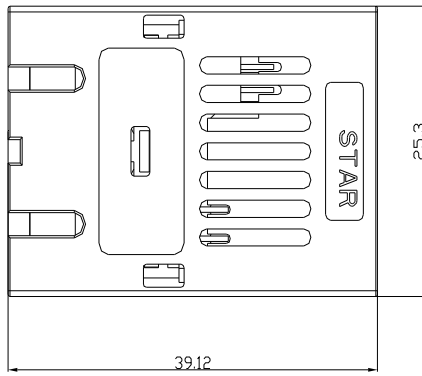
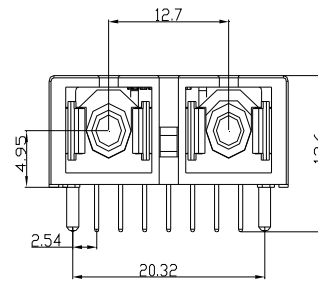
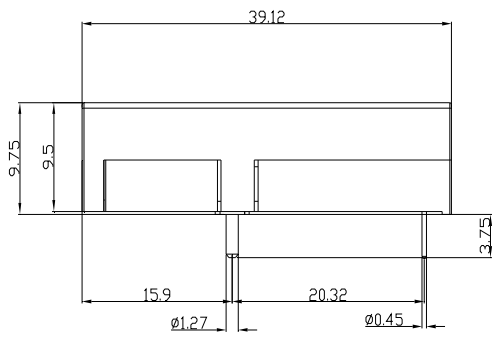

Unit: mm

### Recommended Circuit

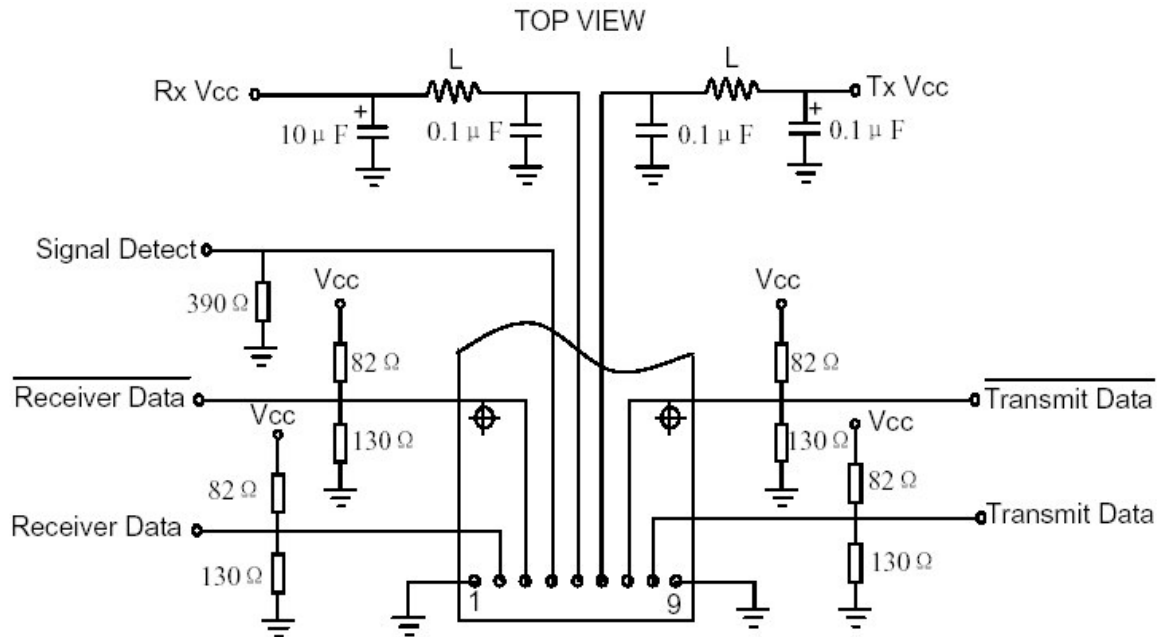

### Obtaining Document

Please visit our website:

[Http://www.staropto.com](http://www.staropto.com)

### Copyright Star Opto Co., Ltd. 2005

All Rights Reserved.

All information contained in this document is subject to change without notice. The products described in this document are NOT intended for use in implantation or other life support applications where malfunction may result in injury or death to persons.

The information contained in this document does not affect or change Star's product specifications or warranties. Nothing in this document shall operate as an express or implied license or indemnity under the intellectual property rights of Star or third parties. All information contained in this document was obtained in the specific environments, and is presented as an illustration. The results obtained in other operating environment may vary.

THE INFORMATION CONTAINED IN THIS DOCUMENT IS PROVIDED ON AN "AS IS" BASIS. In no event will Star be liable for the damages arising directly from any use of the information contained in this document.

**Ordering Information**

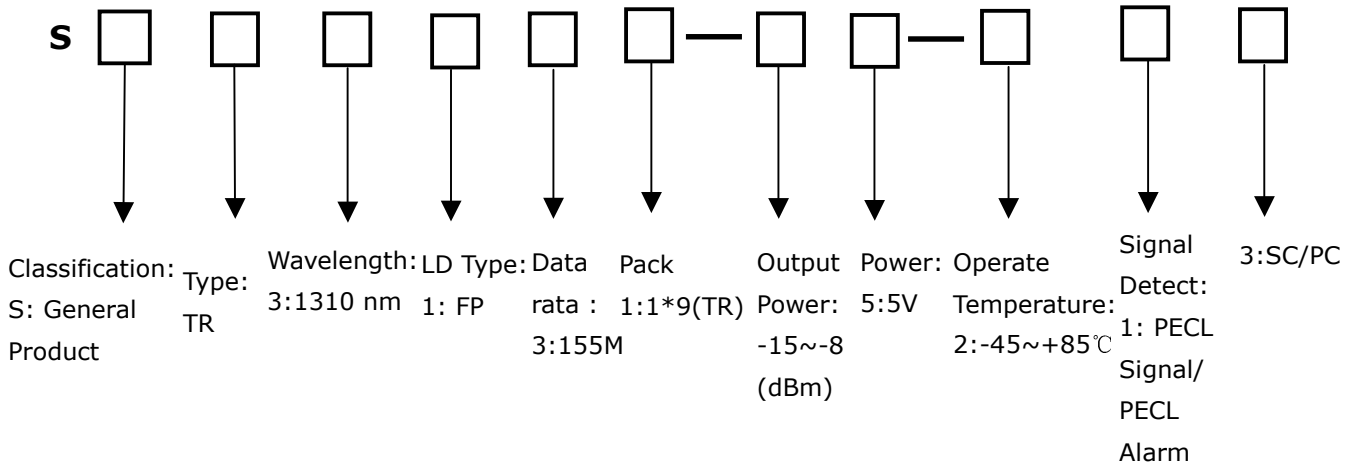

Part number	Product Information
SSTR3131-15-213	1310nm 155Mb/s 1*9 -45~+85°C