

## Reset-Free Polarization Stabilizer – PolaStay™



The PolaStay™ polarization stabilizer actively maintains a stable output state of polarization (SOP) against rapid input SOP fluctuations, compensating for an input polarization discontinuity in as fast as 5 ms, or tracking without resets against a continuous input SOP rotation of up to  $32\pi/s$ . This unique product is a complete system consisting of General Photonics' polarization controller, in-line polarization monitor, and proprietary algorithm. The instrument's output fiber can be either single mode fiber or PM fiber with the output polarization aligned to its slow axis. When a polarizer is placed at the output, the maximum power fluctuation caused by input polarization fluctuation is less than 0.1 dB. This instrument can be used

to eliminate polarization fluctuations in fiber systems, suppress noise figure in optical amplifiers, reduce PDL effects, demultiplex polarization division multiplexed channels, and eliminate polarization fading in coherent communication and fiber sensor systems. The POS-20X line replaces our popular POS-10X line. The most noticeable change is the addition of a front-panel display for easy setup and optimization of operation parameters such as control step size, feedback delay, activation threshold, and minimum or maximum search. Other improvements include reduced minimum optical input power, reduced recovery time, the addition of an electrical feedback port, universal power supply, and higher tracking speed. The POS-20X line includes 3 different configurations (X=2,3, or 4) to meet different application requirements.

### Specifications:

|  |  |
|--|--|
| Operating Wavelength Range <sup>1</sup>  | calibrated wavelength $\pm$ 50nm standard  |
| Calibrated Wavelengths                   | 1550, 1310, 1060nm   |
| SOP Recovery Time                        | < 5 ms (1.5 ms typical)  |
| SOP Rotation Tracking Speed <sup>2</sup> | $32 \pi/s$ , endless tracking & reset free   |
| SOP Accuracy <sup>3</sup>                | < 0.1 dB (PM output fiber)   |
| Repeatability                            | < 0.1 dB   |
| Insertion Loss                           | 0.8 dB typical, 1.2 dB max. (POS-202)<br>0.1 dB intrinsic, < 0.5 dB with connectors (POS-203 polarization controller optical path) |
| Return Loss                              | > 50 dB  |
| Isolation in Orthogonal Polarization     | 20 dB  |
| Minimum Optical Input                    | -30 dBm (POS-202)<br>-35 dBm (POS-203 optical feedback)  |
| Optical Power Handling <sup>4</sup>      | 20 dBm (POS-202)<br>30 dBm (POS-203 polarization controller input)<br>6 dBm (POS-203 optical feedback input)                       |
| Operating Temperature                    | 0 to 50 °C   |
| Storage Temperature                      | -20 to 70 °C   |
| Front Panel Display                      | OLED graphic display   |
| Electrical Feedback                      | BNC connector to accept 0 – 4.5 V analog voltage   |
| Power Supply                             | 100 – 240 VAC, 50 – 60 Hz  |
| Communication Interfaces                 | USB, Ethernet, RS-232, and GPIB  |
| Dimensions                               | 2U 19 inch half rack width 14" (L) x 8.5" (W) x 3.5" (H)   |

### Notes:

Specifications listed in table apply for standard 1310 or 1550nm operation at  $23 \pm 5$  °C.  
1. For standard versions with PM outputs. Other wavelength ranges are available. Specifications may be different for instruments with different wavelength or power ranges or different output fibers.

2. For input power  $>$ -25 dBm for POS-202, or optical feedback signal  $>$ -35 dBm for POS-203 and POS-204.

3. The output power fluctuation caused by SOP fluctuation after passing through a polarizer.

4. Standard version. Higher power ranges may be possible by special request.

### Features:

- Reset free operation
- 5 ms recovery time
- $32\pi/s$  tracking speed
- Front panel control parameter setup
- Low insertion loss

### Applications:

- Optical amplifier polarization stabilization
- Polarization demultiplexing
- Elimination of polarization fading
- Coherent communication

### Ordering Information:

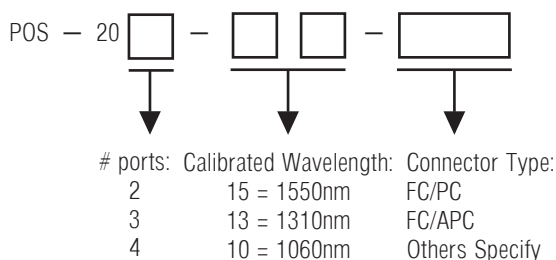

## Reset-Free Polarization Stabilizer – PolaStay™

### Function Diagrams:

POS-202 (2 optical ports)

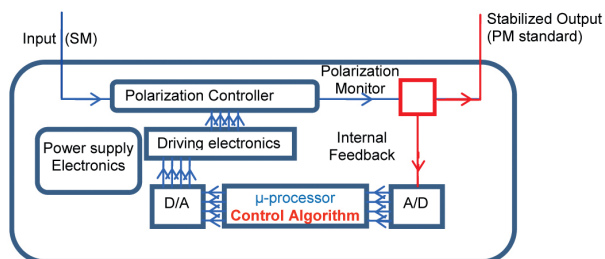

POS-202: The instrument has two optical ports on the front panel for input and output. It has an internal polarization monitor. It stabilizes output polarization to its internal reference state (linear, aligned to slow axis for a PM output unit).

POS-203 (3 optical ports)

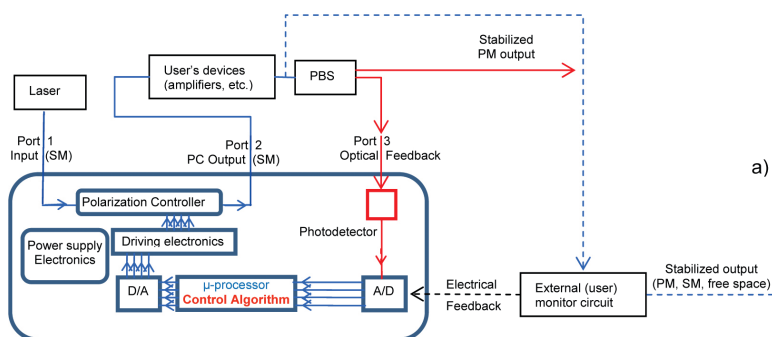

a)

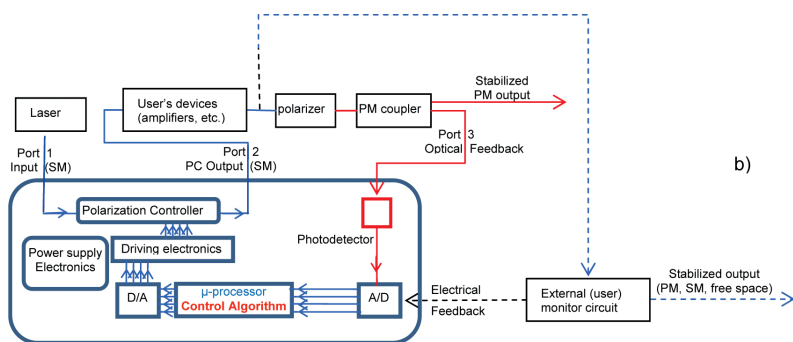

b)

POS-203: The instrument has three optical ports on the front panel for input, output, and an external optical feedback signal. It also has an electrical port to accept an external electrical feedback signal. Either the optical or electrical feedback signal can be used for stabilizer control. The polarization controller tunes the output polarization to maximize or minimize the selected feedback signal. Diagram a) shows a sample setup for minimum search, in which a PBS is used to monitor the output polarization from the user device. Diagram b) shows a sample setup for maximum search, in which a polarizer followed by a PM coupler is used to monitor the output polarization from the user device. In both cases, the resulting optical monitor signal is fed back to port 3 on the front panel of the stabilizer. The user can also use his own optical/electrical polarization monitoring circuit to generate an electrical feedback signal to control the stabilizer. In this case, the optical path follows the blue dotted line, and the electrical feedback signal is connected to the corresponding BNC connector on the rear panel of the stabilizer.

POS-204 (4 optical ports)

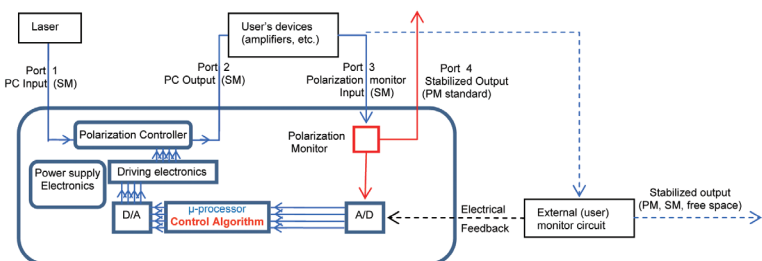

POS-204: The instrument has four optical ports on the front panel for polarization controller input and output, and for polarization monitor input and output. As with the POS-203, there is also an electrical port to accept an external electrical feedback signal from a user's own external monitor circuit. In this case, the optical path follows the blue dotted line, and the electrical feedback signal is connected to the corresponding BNC connector on the rear panel of the stabilizer. Either the optical or electrical feedback signal can be used for stabilizer control. The polarization controller tunes the output polarization to maximize or minimize the selected feedback signal.

# Reset-Free Polarization Stabilizer – PolaStay™

Typical Performance Data:

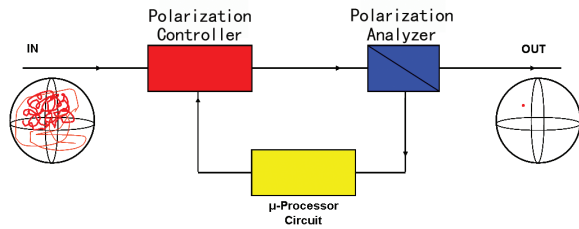

Figure 1. PolaStay™ polarization stabilizer function diagram.

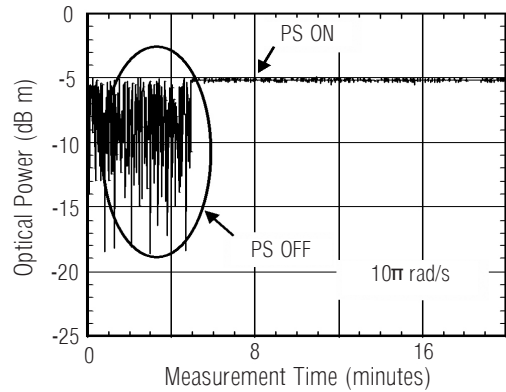

Figure 2. Polarization stabilization against endless half-wave plate rotation at  $10\pi$  rad/s

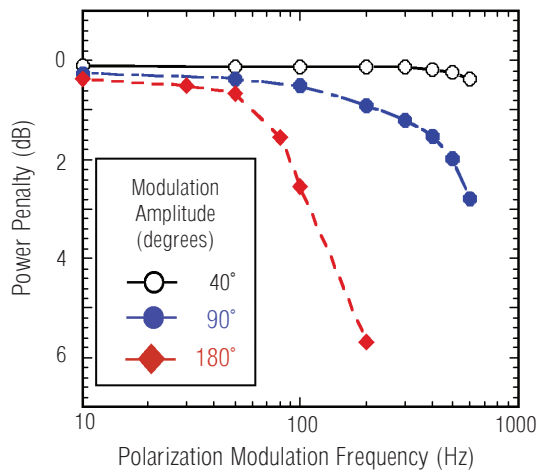

Figure 3. Polarization stabilization against sinusoidal polarization modulation.

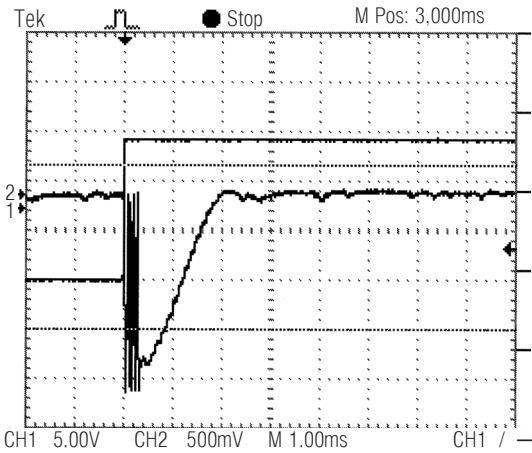

Figure 4. Polarization stabilization against a step polarization change.

## Accessories:

|                    |       |
|--------------------|-------|
| NoTail™ Isolator   | p. 91 |
| NoTail™ Polarizer  | p. 90 |
| NoTail™ Coupler    | p. 85 |
| NoTail™ PM Coupler | p. 86 |
| NoTail™ PBC/S      | p. 87 |
| NoTail™ Circulator | p. 92 |
| Rack Mount Kit     | p. 83 |