

405nm 100mw~120mw Single Mode Laser Diode | SM LD |3.8mm Package

405nm LD |100mw~120mw Power|3.8mm small Package | Single Mode Beam

WSLD-405-120m-1

Wavespectrum Laser Group

www.wavespectrum-laser.com

405nm Laser Diode		Wavespectrum Laser Group	
PARAMETER	SYMBOL	VALUE	UNIT
Reverse Voltage	V_r	5.0	V
Operating Temperature	T_{op}	-10~+70	°C
Storage Temperature	T_{stg}	-40~+85	°C
Lead soldering temperature (10 sec.)	T_{is}	260	°C
Features: <ul style="list-style-type: none"> ● 405nm ● Single Mode Beam ● 3.8mm Package 			
Applications: <ul style="list-style-type: none"> ● Medical Laser Treatment ● Printing ● Others 			
Specifications	WSLD-405-120m-1		
	Min	Type	Max
Center Wavelength@25°C	400nm	405nm	410nm
Spectral Width (FWHM)	2.0nm		
Output Power	----	100mW	120mW
Laser Type	Single Mode		
Beam Divergence (FWHM)	$15^\circ \pm x 7^\circ //$	$19.5^\circ \pm x 9^\circ //$	$23^\circ \pm x 12^\circ //$
Slope Efficiency	1.2mW/mA	1.4mW/mA	1.9mW/mA
Threshold Current (Typ.)	----	35mA	50mA
Operating Current (Typ.)	----	120mA	140mA
Operating Voltage	----	4.8V	5.5V
Package Style	3.8mm		



Drawing

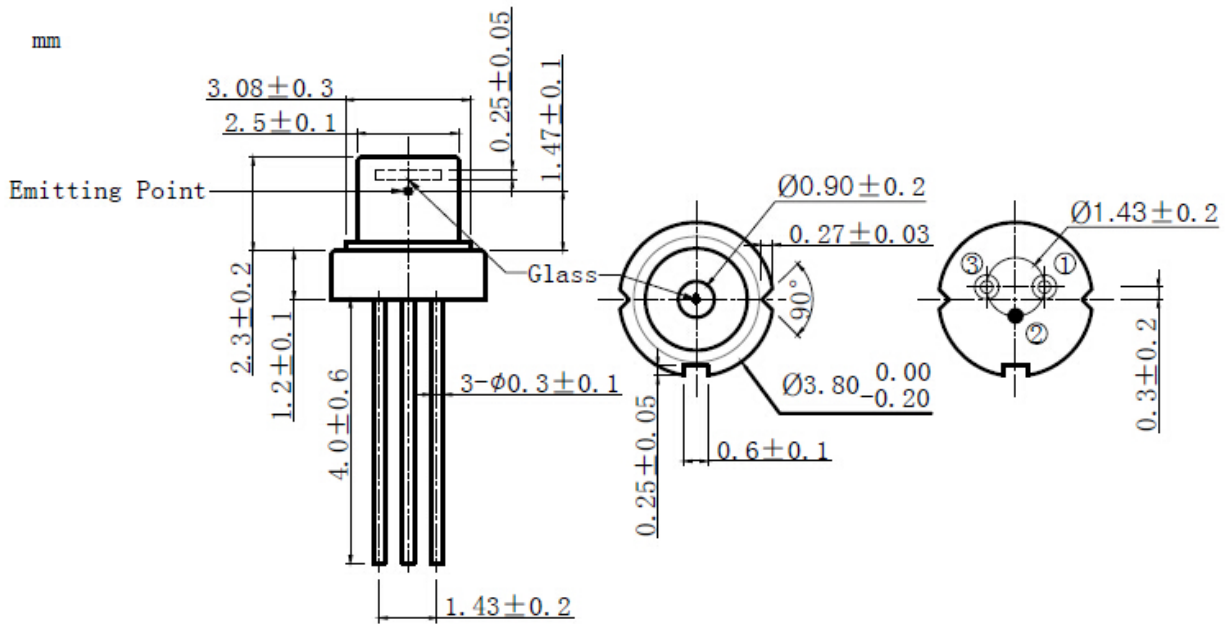

PIN Bottom View:

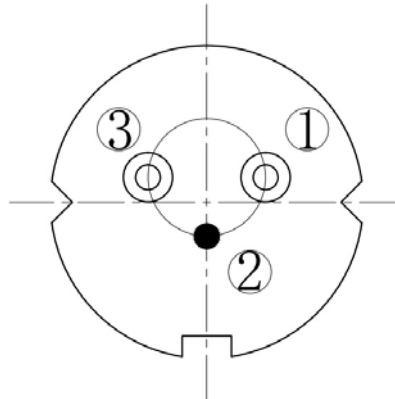

1	LD(+)
2	GND
3	LD(-)

Electrically shorten LD module and store in non-extreme conditions.

Suggest using the constant current power supply.

